

DETAIL NOT TO SCALE

DETECTABLE WARNING SURFACE PLACEMENT

STREET DESIGN

Town of Hope Mills, North Carolina

Detail ST-43

February 28, 2015 Original

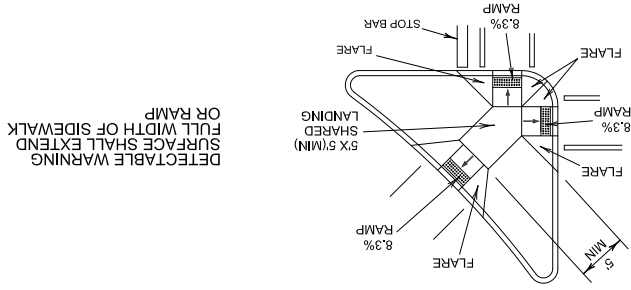

CURB RAMPS AT MEDIAN ISLANDS

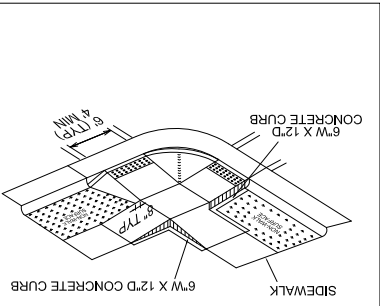
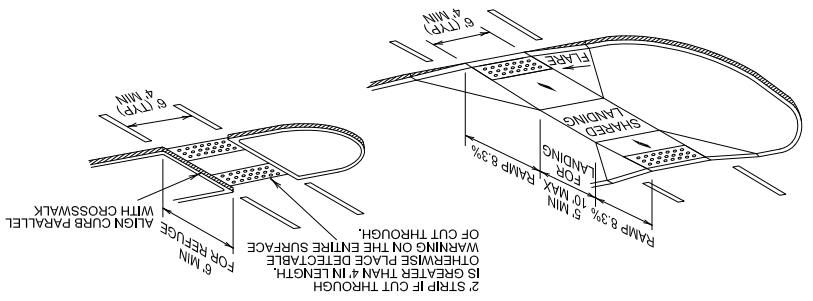

TYPE R-4

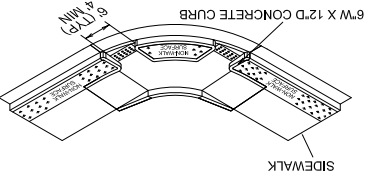

TYPE R-3

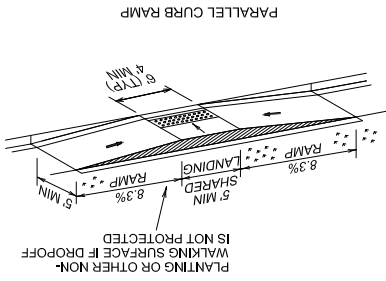

TYPE R-2

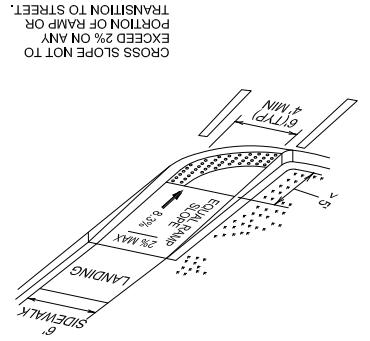

TYPE R-1A

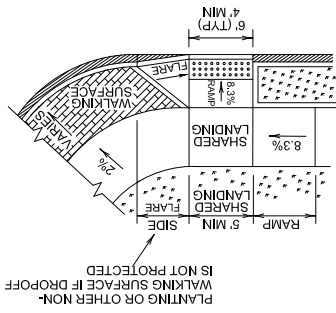

TYPE N-2 & N-3

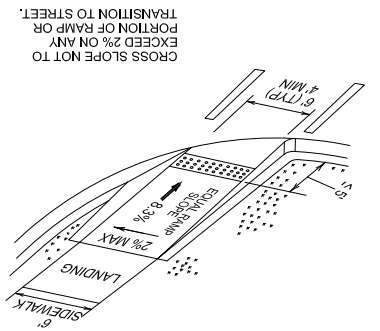

TYPE N-1, N-1A & R-1

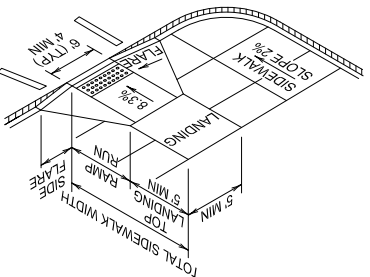

TYPE N-3A